

GLASS DOOR MERCHANDISERS



Countertop Glassdoor Merchandisers

Countertop Refrigerated Display Cases - Curved/Square

Black Exterior Glass Door Refrigerator Merchandisers



"WE MAKE THE KITCHEN BETTER!"

Toll Free: 855-855-0399 Email: info@atosausa.com
www.atosa.com | www.atosausa.com
California, Colorado, Florida, Georgia, Illinois,
Massachusetts, New Jersey, Ohio, Texas, Washington

Countertop Glassdoor Merchandisers

MODELS:

CTD-3 / CTD-3S / CTD-5

Standard Features

- Black exterior cabinet with black door frame and white interior
- Environmentally friendly R600a refrigerant
- CTD-3/CTD-5 are forced air cooling and CTD-3S is cold wall cooling
- Foamed-in-place high density polyurethane insulation
- Double pane glass door with recessed door handle
- Door lock standard
- Mechanical controller
- Pre-installed removable PVC coated wire shelves standard
- Certified for packaged foods and bottled beverages
- Maintains temperatures between 33°F- 41°F
- Magnetic door gasket standard for positive door seal
- LED interior lighting
- Leveling legs
- 5' cord with NEMA 5-15 plug standard



CTD-3



CTD-3S



CTD-5

For the best results of food preservation we recommend setting your refrigerator between 33 °F to 38 °F

1. Don't forget to leave the unit some room to breathe!
2. Please clean the condenser frequently to give the unit more fresh air.



1 YEAR PARTS AND LABOR WARRANTY (US ONLY)
5 YEAR COMPRESSOR PART WARRANTY (US ONLY)





"WE MAKE THE KITCHEN BETTER!"

Toll Free: 855-855-0399 Email: info@atosausa.com
 www.atosa.com | www.atosausa.com
 California, Colorado, Florida, Georgia, Illinois,
 Massachusetts, New Jersey, Ohio, Texas, Washington

SPECIFICATIONS

Models	Door	Capacity (Cu.Ft.)	Shelves	Amps(A)	Voltage (V/Hz/Ph)	HP	Refrigerant	Exterior Dimensions (inch)	Net Weight (lbs)	Gross Weight (lbs)
CTD-3	1	2.4	3	1.5	115/60/1	1/10	R600a	17 ^{1/4} ×19 ^{3/4} ×27 ^{1/2}	53	57
CTD-3S	1	2.4	3	1.5	115/60/1	1/8	R600a	18 ^{1/8} ×18 ^{1/2} ×33	64	70
CTD-5	1	4.6	4	1.7	115/60/1	1/8	R600a	21 ^{1/4} ×22×33 ^{3/4}	88	95

PLAN VIEW

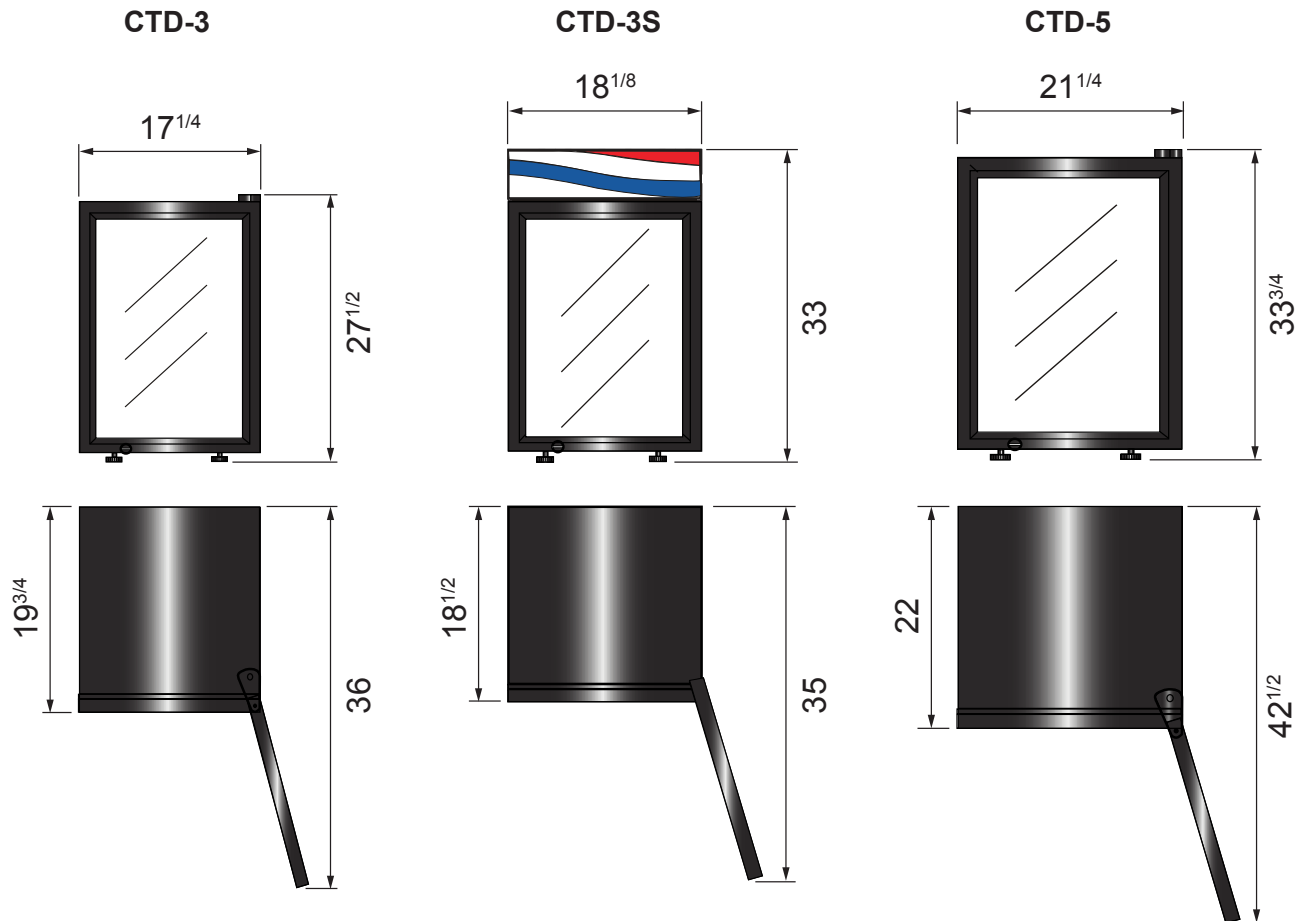

Door lock

LED lights

Epoxy shelves

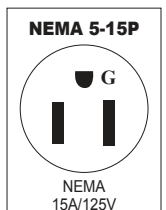



"WE MAKE THE KITCHEN BETTER!"

Toll Free: 855-855-0399 Email: info@atosausa.com
www.atosa.com | www.atosausa.com
California, Colorado, Florida, Georgia, Illinois,
Massachusetts, New Jersey, Ohio, Texas, Washington

Countertop Refrigerated Display Cases

- Curved / Square

MODELS:

CRDC-35 / CRDC-46 / CRDS-42 / CRDS-56

Standard Features

- Stainless steel exterior & interior with black frames
- Rear mount compressor with environmentally friendly R290 refrigerant
- Dixell digital controller
- Two(2) stainless steel shelves standard
- Defog feature to ensure the glass stays clear
- Maintains temperatures between 33°F – 41°F
- Magnetic door gasket(s) standard for positive door seal
- Two(2) rear sliding doors
- LED interior lighting
- Leveling legs
- NEMA 5-15 plug



CRDC-35



CRDC-46



CRDS-56



CRDS-42

For the best results of food preservation we recommend setting your refrigerator between 33 °F to 38°F

1. Don't forget to leave the unit some room to breathe!
2. Please clean the condenser frequently to give the unit more fresh air.



1 YEAR PARTS AND LABOR WARRANTY (US ONLY)
5 YEAR COMPRESSOR PART WARRANTY (US ONLY)





"WE MAKE THE KITCHEN BETTER!"

Toll Free: 855-855-0399 Email: info@atosausa.com
 www.atosa.com | www.atosausa.com
 California, Colorado, Florida, Georgia, Illinois,
 Massachusetts, New Jersey, Ohio, Texas, Washington

SPECIFICATIONS

Models	Door	Capacity (Cu.Ft.)	Shelves	Amps(A)	Voltage (V/Hz/Ph)	HP	Refrigerant	Exterior Dimensions (inch)	Net Weight (lbs)	Gross Weight (lbs)
CRDC-35	2	3.5	2	2	115/60/1	1/5	R290	27 ^{3/5} ×22 ^{1/10} ×26 ^{2/5}	139	172
CRDC-46	2	4.6	2	2	115/60/1	1/5	R290	35 ^{2/5} ×22 ^{1/10} ×26 ^{2/5}	154	200
CRDS-42	2	4.2	2	2	115/60/1	1/5	R290	27 ^{3/5} ×22 ^{1/10} ×26 ^{2/5}	143	192
CRDS-56	2	5.6	2	2	115/60/1	1/5	R290	35 ^{2/5} ×22 ^{1/10} ×26 ^{2/5}	165	214

PLAN VIEW



LED lights

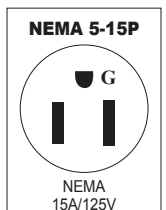



"WE MAKE THE KITCHEN BETTER!"

Toll Free: 855-855-0399 Email: info@atosausa.com
www.atosa.com | www.atosausa.com
California, Colorado, Florida, Georgia, Illinois,
Massachusetts, New Jersey, Ohio, Texas, Washington

Black Exterior Glass Door Refrigerator Merchandiser

MODELS:

MCF8725GR

Standard Features

- Black steel exterior with stainless steel interior
- Lighted header panel
- LED interior lighting standard
- Dixell electronic controller
- Four(4) shelves standard per section
- Double pane glass door
- Self-closing door(s) with automatic stay open feature
- Recessed door handle
- Door lock(s) standard
- Magnetic door gasket
- Self-contained bottom mount refrigeration system with environmentally friendly R290 refrigerant
- Pre-installed casters
- Pre-installed shelves
- NEMA-5-15P plug standard



Optional Accessories

- Extra shelves – includes 4 shelf clips per shelf

For the best results of food preservation we recommend setting your refrigerator between 33 °F - 38 °F

1. Don't forget to leave the unit some room to breathe!
2. Please clean the condenser frequently to give the unit more fresh air.



2 YEAR PARTS AND LABOR WARRANTY (US ONLY)
5 YEAR COMPRESSOR PART WARRANTY (US ONLY)





"WE MAKE THE KITCHEN BETTER!"

Toll Free: 855-855-0399 Email: info@atosausa.com
 www.atosa.com | www.atosausa.com
 California, Colorado, Florida, Georgia, Illinois,
 Massachusetts, New Jersey, Ohio, Texas, Washington

SPECIFICATIONS

Models	Door	Capacity (Cu.Ft.)	Shelves	Casters (inch)	Amps (A)	Voltage (V/Hz/Ph)	HP	Refrigerant	Exterior Dimensions (inch)	Net Weight (lbs)	Gross Weight (lbs)
MCF8725GR	1	11.1	4	2	2.1	115/60/1	1/7	R290	24 ^{1/5} ×24×76 ^{1/5}	227	251

PLAN VIEW

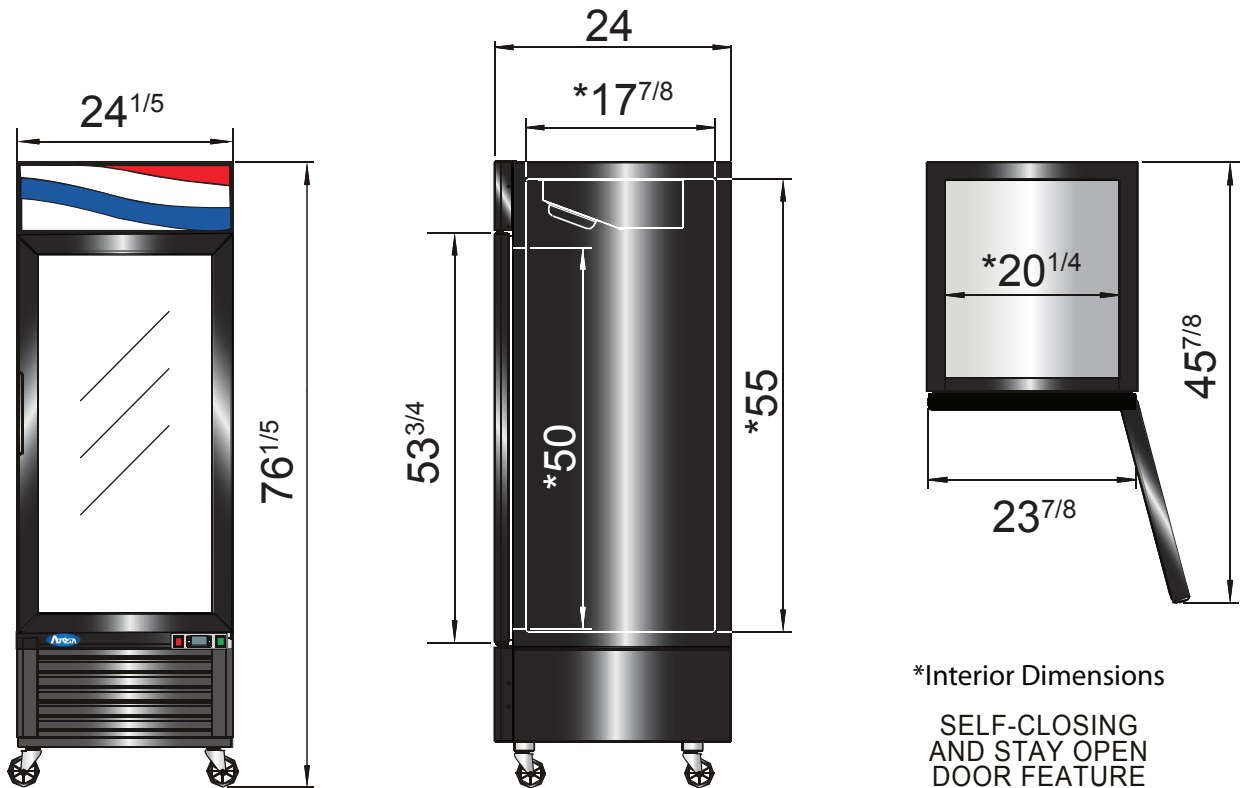

Casters



Temperature control



Door lock



LED lights



Epoxy shelves



NEMA 5-15P



NEMA
15A/125V



“WE MAKE THE KITCHEN BETTER!”

Toll Free: 855-855-0399 Email: info@atosausa.com
www.atosa.com | www.atosausa.com
California, Colorado, Florida, Georgia, Illinois,
Massachusetts, New Jersey, Ohio, Texas, Washington

Black Exterior Glass Door Refrigerator Merchandisers

Standard Features

- Black steel exterior with stainless steel interior
- Lighted header panel
- LED interior lighting standard
- Dixell electronic controller
- Four(4) shelves standard per section
- Double pane glass door(s)
- Self-closing door(s) with automatic stay open feature
- Recessed door handle
- Door lock(s) standard
- Magnetic door gasket
- Self-contained bottom mount refrigeration system with environmentally friendly R290 refrigerant
- Pre-installed casters
- Pre-installed shelves
- NEMA-5-15P plug standard

Optional Accessories

- Extra shelves – includes 4 shelf clips per shelf



MCF8722GR
MCF8723GR

For the best results of food preservation we recommend setting your refrigerator between 33 °F to 38 °F

1. Don't forget to leave the unit some room to breathe!
2. Please clean the condenser frequently to give the unit more fresh air.



2 YEAR PARTS AND LABOR WARRANTY (US ONLY)
5 YEAR COMPRESSOR PART WARRANTY (US ONLY)

MODELS:

MCF8722GR / MCF8723GR / MCF8724GR



MCF8722GR



MCF8723GR



MCF8724GR



For confirmation and updates on the latest energy star models, please visit energystar.gov



“WE MAKE THE KITCHEN BETTER!”

Toll Free: 855-855-0399 Email: info@atosausa.com
 www.atosa.com | www.atosausa.com
 California, Colorado, Florida, Georgia, Illinois,
 Massachusetts, New Jersey, Ohio, Texas, Washington

SPECIFICATIONS

Models	Door	Capacity (Cu.Ft.)	Shelves	Casters (inch)	Amps (A)	Voltage (V/Hz/Ph)	HP	Refrigerant	Exterior Dimensions (inch)	Net Weight (lbs)	Gross Weight (lbs)
MCF8722GR	1	19.4	4	2	2.1	115/60/1	1/7	R290	27×31 ^{1/2} ×81 ^{1/5}	293	326
MCF8723GR	2	43.8	8	2	3.2	115/60/1	1/5	R290	54 ^{2/5} ×31 ^{1/2} ×81 ^{1/5}	485	540
MCF8724GR	3	69.5	12	2	4.2	115/60/1	1/4	R290	81 ^{9/10} ×31 ^{1/2} ×81 ^{1/5}	653	761

PLAN VIEW

MCF8722GR

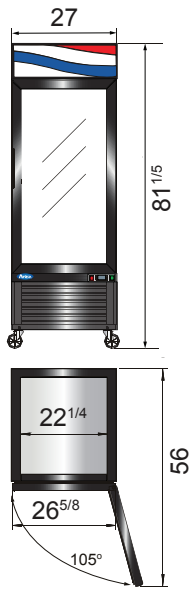

MCF8723GR

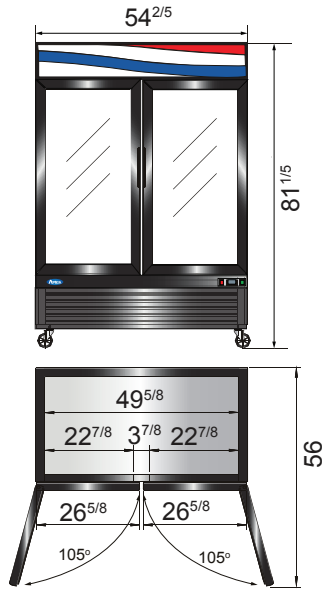

MCF8724GR

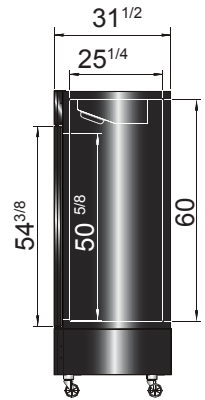
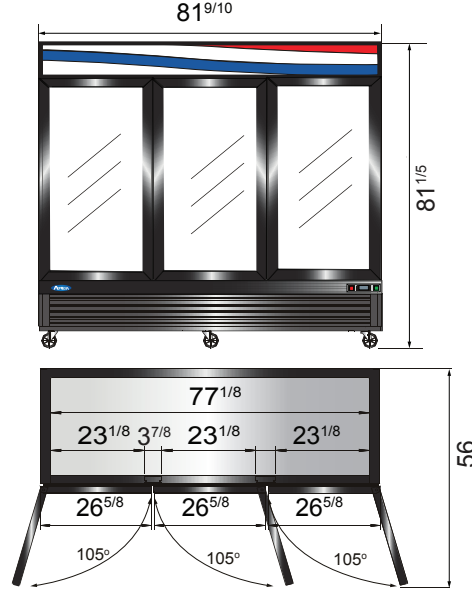

*Interior Dimensions

SELF-CLOSING AND STAY OPEN DOOR FEATURE

Casters



Temperature control



Door lock



LED lights



Epoxy shelves



NEMA 5-15P

