

SPIRAL POTATO FRY CUTTER

FEATURES

- Easy to use
- Cuts fries in continuous spiral shape

Item	Description
42159	Spiral Potato Fry Cutter



CUT STYLE GUIDE	
Foods	Cut Style
Potatoes Apples	Spiral



COUNTERTOP VERTICAL FRUIT AND VEGETABLE WEDGE CUTTER

FEATURES

- Cut fruit and vegetable wedges
- Sharp stainless steel blades
- Great for cutting lemons, limes, potatoes, oranges, and tomatoes



CUT STYLE GUIDE	
Foods	Cut Style
Lemon Lime Orange Tomatoes Onion Potatoes	Wedge



Item	Description
41864	Vertical Wedge Cutter, 6 Slice
41865	Vertical Wedge Cutter, 8 Slice



COUNTERTOP VERTICAL FRUIT AND VEGETABLE SLICER

FEATURES

- Slice fruits and vegetables
- Sharp stainless steel blades
- Great for slicing onions, lemons, potatoes, limes, tomatoes, and oranges

Item	Description
41862	Countertop Vertical Fruit and Vegetable Slicer, 3/16" Cutter Blade
41863	Countertop Vertical Fruit and Vegetable Slicer, 1/4" Cutter Blade



CUT STYLE GUIDE	
Foods	Cut Style
Onions Squash Limes Potatoes Lemons Oranges	Slice

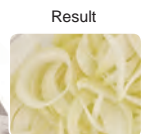

Storage container is sold separately



COUNTERTOP LETTUCE CHOPPER

FEATURES

- Chop lettuce in the fraction of the time
- Sharp scalloped blades, designed to cut 1" x 1" squares
- Comes with non-slip feet for extra stability

Item	Description
41866	1"x1" Vegetable Cutter



CUT STYLE GUIDE	
Foods	Cut Style
Lettuce Cabbage 3" Onions Bell Pepper Cucumbers Cantaloupes Cooked Chicken	Shred Slice

POTATO FRY/WEDGE CUTTER

FEATURES

- Body and handle are made of heavy-duty cast iron
- Assembly frame pusher block and cutting frame are made of stainless steel
- Designed to be wall-mounted or place on table top
- Available with 1/4" blade or 3/8" cut blade
- Additional potato cutter frames also available
- Some assembly required

Item	Description
24242	Potato Cutter with 3/8" blade
24489	Potato Cutter with 1/4" blade
24598	Potato Cutter with 1/2" blade
24243	Blade for Potato Cutter and pusher - 1/4"
24244	Blade for Potato Cutter and pusher - 3/8"
24245	Blade for Potato Cutter and pusher - 1/2"
24246	Potato Cutter Wedges Blade and pusher - 6 Slices
24247	Potato Cutter Wedges Blade and pusher- 8 Slices



CUT STYLE GUIDE	
Foods	Cut Style
Onions Celery Peppers Tomatoes Potatoes Apples Pears	Wedge Dice

24242

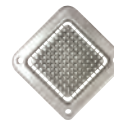

24243



24246



24245



24247

WALL MOUNTED VERTICAL POTATO FRY CUTTER

FEATURES

- Designed to easily and effectively slice potatoes
- Comes with interchangeable French fry cutting blades
- Designed for easy disassembling, making cleaning safe and easy

Item	Description
41856	3/8" Cutter Blade, 8"W x 14.5"D x 16.5"H (Open)/ 15.75"H (Closed), Weight: 9.1 lbs.
41857	1/4" Cutter Blade, 8"W x 14.5"D x 16.75"H (Open)/ 15.75"H (Closed), Weight: 9.2 lbs.
41858	1/2" Cutter Blade, 8"W x 14.5"D x 16.75"H (Open)/ 15.75"H (Closed), Weight: 9.2 lbs.

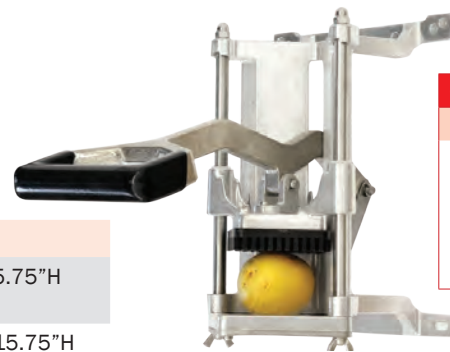

CUT STYLE GUIDE	
Foods	Cut Style
Onions Celery Peppers Tomatoes Potatoes Apples Pears	Dice

41856

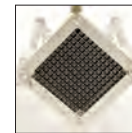

3/8" Blade
(Item 77364)

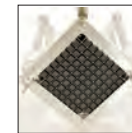

1/4" Blade
(Item 77363)

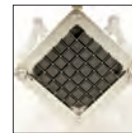

1/2" Blade
(Item 76934)

COUNTERTOP VERTICAL POTATO CUTTER

FEATURES

- Designed to easily and effectively slice potatoes.
- Comes equipped with four non-skid feet for added stability
- Sharp, interchangeable stainless steel cutting grid
- Built with a heavy duty metal frame ensures long lasting performance

Item	Description
41859	3/8" Cutter Blade, 8"D x 8"W x 18.75"H, Weight: 5.65 lbs.
41860	1/4" Cutter Blade, 8"D x 8"W x 18.75"H, Weight: 5.65 lbs.
41861	1/2" Cutter Blade, 8"D x 8"W x 18.75"H, Weight: 5.65 lbs.



41859



CUT STYLE GUIDE	
Foods	Cut Style
Onions Celery Peppers Tomatoes Potatoes Apples Pears	Dice

MANUAL TOMATO SLICER

FEATURES

- Cast aluminum and stainless steel
- Cut tomato quickly and precisely without crushing the shape
- Reduces preparation time while keeping your tomato nice and clean

Item	Description
10929	Cast Aluminum and Stainless Steel 1/4" Tomato Slicer
10930	Cast Aluminum and Stainless Steel 3/16" Tomato Slicer
10048	Replacement Blades for Item 10929
10049	Replacement Blades for Item 10930

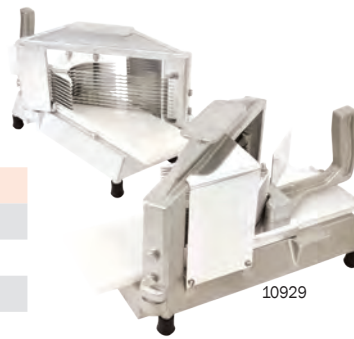

CUT STYLE GUIDE	
Foods	Cut Style
Tomatoes Strawberries Mushroom Oranges	Scalloped-Blade Slice

MANDOLINE WITH 5 INTERCHANGEABLE BLADES

FEATURES

- Comes with 5 interchangeable cutting blades and a plastic hand pusher
- Rubber coated handles and feet
- Top levers allow thickness adjustments to 3/8"

Item	Description
13659	18/10 Stainless steel mandoline vegetable slicer, Sizes for the julienne blades are 4.5mm, 7mm, 10mm.



CUT STYLE GUIDE	
Foods	Cut Style
Bell Peppers Onions Cucumber	Slice

APPLE PEELER AND CORER

FEATURES

- Helps you to peel, slice and core apples in seconds
- Made with stainless steel and painted red base
- Great tool for making healthy snack, salad, and pastries

Item	Description
10829	Apple Peeler and Corer



CUT STYLE GUIDE	
Foods	Cut Style
Apple Potato	Core Peel

BOX GRATER *Sold by the case*

FEATURES

- Easily grate and slice your vegetables, potatoes, or cheese
- Stainless steel construction
- Easy to use and clean.

Item	Description	Dimensions	Quantity/Case (pcs.)
80736	Stainless Steel Tapered Box Grater	9" x 4" x 3.24"	12
80737	Stainless Steel Box Grater	9" x 4" x 4"	12



MANUAL PEELER *Sold by the case*

FEATURES

- Equipped with a razor sharp blade for easy peeling

Item	Description	Quantity/Case (pcs.)
14142	Manual Peeler	10



CRINKLE CUT SERRATOR *Sold by the case*

FEATURES

- Made of durable stainless steel with easy to grip wooden handle
- Perfect for making crinkle-cut fries and hashbrowns

Item	Description	Quantity/Case (pcs.)
80006	7" / 178mm - Stainless steel serrator with wood handle	12



SALAD SPINNER Available only in Canada

FEATURES

- Sealed rotating system to ensure food safety
- Meets the FDA's hygiene standards
- Comes with a non-slip handle that can be rotated in different directions

Item	Description	Weight
43454	19L salad spinner 18.3" (Dia.) x 22.24"(H)	4.25 kg
43637	9.5L salad spinner 15.7"(Dia.) x 18.5"(H)	3.27 kg



43454

DREDGERS Sold by the case

FEATURES

- Use these shakers for sugar, spices, and other condiments
- Ideal for pizza shops, coffee shops, or any busy kitchen operations

Item	Description	Quantity/Case (pcs.)
80742	10 oz Stainless Steel Dredge with Handle	12
80743	10 oz Stainless Steel Dredge without Handle	12
80744	10 oz Aluminum Dredge with Handle	12
80745	10 oz Aluminum Dredge without Handle	12



80742

80743



80744

80745

DIAL SPRING SCALE

FEATURES

- Enameled steel construction
- Not legal for trade

Item	Description	Increments	Dimensions
46752	Dial Spring Scale 2.2 lbs.	2.2 lbs x 5 g	23" x 18" x 18"
46753	Dial Spring Scale 4.4 lbs.	4.4 lbs x 10 g	23" x 18" x 18"
10852	Dial Spring Scale 6.6 lbs.	6 lbs x 1/2 oz	8.75" x 8" x 8.75"
10853	Dial Spring Scale 8.8 lbs.	8 lbs x 1 oz	8.75" x 8" x 8.75"
46446	Dial Spring Scale 11 lbs	11 lbs x 20 g	8.3" x 5.5" x 8.3"
46447	Dial Spring Scale 22 lbs	22 lbs x 50 g	10.2" x 9.1" x 11.8"
46571	Dial Spring Scale 33 lbs.	33 lbs x 4 oz	10.25" x 9.5" x 10.25"
10848	Dial Spring Scale 44 lbs.	44 lbs x 2 oz	10.25" x 9.5" x 10.25"
46570	Dial Spring Scale 55 lbs.	55 lbs x 4 oz	12" x 9.5" x 12.5"
10851	Dial Spring Scale 66 lbs.	66 lbs x 4 oz	12" x 12" x 13"
46448	Dial Spring Scale 110 lbs.	110 lbs x 4 oz	11.8" x 8.26" x 11.8"

NEW

NEW

NEW

NEW

NEW

NEW

NEW



46571

PLATFORM SCALE

FEATURES

- Ideal for a wide variety of applications including food preparation
- Large, easy to read dials with both "LB" and "KG" measure
- A zero adjust allows for compensation
- Not legal for trade

Item	Weight Capacity	Dimensions	Scale Gross Dimensions	Platform Gross Dimensions
10843	Max. 50 kg / 110 lbs. Min. 1 kg / 2.2 lbs.	24.5" x 12.3" x 38.8"	36" x 12" x 4"	23" x 12" x 5"
10840	Max. 100 kg / 220 lbs. Min. 2 kg / 4.4 lbs.	24.5" x 12.3" x 38.8"	36.5" x 13.4" x 8.7"	26" x 14.4" x 6.7"
10841	Max. 150 kg / 330 lbs. Min. 5 kg / 11 lbs.	24.5" x 12.3" x 44.5"	43.3" x 13.4" x 8.7"	26" x 14.4" x 6.7"
10842	Max. 200 kg / 440 lbs. Min. 5 kg / 11 lbs.	35.5" x 21.3" x 49.3"	45" x 15" x 10"	38" x 24" x 10.9"



Platform Scale

HANGING SCALE NEW

FEATURES

- Easy to read dials with both “LB” and “KG” measure
- *Not legal for trade.

Item	Description	Increments
43827	15.7" x 15.7" x 8.7", Hanging Dial Scale, 10 kg / 22 lbs	22 lbs x 2 oz / 10 kg x 50 g



23815

ALUMINUM LIQUID MEASURING CUP *Sold by the case*

FEATURES

- Lightweight and reliable
- Constructed with riveted handles
- Increment lines for dry and liquid ingredient
- Available sizes are ½ qt, 1 qt, 2 qt and 4 qt

Item	Description	Quantity/Case (pcs.)
80400	Aluminum Measuring Cup 1/2 QT/ 480 mL	12
80401	Aluminum Measuring Cup 1 QT/ 950 mL	12
80402	Aluminum Measuring Cup 2 QT/ 1900 mL	12
80403	Aluminum Measuring Cup 4 QT/ 3800 mL	12



80401

CLEAR POLYCARBONATE MEASURING CUPS *Sold by the case*

FEATURES

- Molded, one-piece polycarbonate construction resists chips and cracks.
- Raised external markings on a matte finish displays both quarts and liters.
- Ideal for home use and commercial kitchens.
- Neatly stackable for easy storage.
- The tapered, open handle allows for easy use and a stable grip.
- Dishwasher and freezer safe.

Item	Description	Quantity/Case (pcs.)
80570	Polycarbonate Measuring Cup- 0.26 QT / 250 mL	12
80571	Polycarbonate Measuring Cup- 0.53 QT / 500 mL	12
80572	Polycarbonate Measuring Cup- 1 QT/ 1000 mL	12
80573	Polycarbonate Measuring Cup- 2 QT / 1900 mL	12
80574	Polycarbonate Measuring Cup- 4 QT / 3800 mL	12
80575*	Polycarbonate Measuring Cups- 5 pcs. /set	1



80575



CLEAR PLASTIC UTILITY SCOOP *Sold by the case*

FEATURES

- Lightweight and easy to clean
- Good alternative to metal scoops
- Perfect for scooping many small items, such as spices, bulk, sugar and ice

Item	Description	Quantity/Case (pcs.)
80322	6 oz Utility Scoop, Clear	12
80323	32 oz Utility Scoop, Clear	12
80324	64 oz Utility Scoop, Clear	12



80324

80323

80322

ALUMINUM SCOOP WITH FLAT BOTTOM *Sold by the case*

FEATURES

- Single-piece construction for better durability
- Straight front-edge and tapered end for reaching bottoms and corners
- Ideal for ice, flour, and any bulk ingredients

Item	Description	Quantity/ Case (pcs.)
80117	4 oz / 118 mL, Flat Bottom, Aluminum	12
80118	7 oz / 207 mL, Flat Bottom, Aluminum	12
80119	16 oz / 473 mL, Flat Bottom, Aluminum	12
80120	24 oz / 710 mL, Flat Bottom, Aluminum	12



80117



80846

ICE SCOOP *Sold by the case*

FEATURES

- Perfect for scooping ice, flour, and/or any other bulk ingredients
- Made of stainless steel

Item	Description	Quantity/ Case (pcs.)
80846	4 oz Stainless Steel Ice Scoop	12



27682



27683



27684

ALUMINUM SCOOP WITH ROUND BOTTOM *Sold by the case*

FEATURES

- One-piece seamless design and the grooved handles give the scoops extra strength
- Compared to plastic scoops, aluminum scoops are break resistant
- Perfect for scooping many small items, such as spices, bulk, sugar and ice

Item	Description	Quantity/ Case (pcs.)
27679	5 oz Aluminum Scoop	12
27680	12 oz Aluminum Scoop	12
27681	24 oz Aluminum Scoop	12
27682	38 oz Aluminum Scoop	12
27683	58 oz Aluminum Scoop	12
27684	85 oz Aluminum Scoop	12



44450

STAINLESS STEEL MEASURING CUP SET

FEATURES

- Perfect for measuring flour, and/or any other bulk ingredients

Item	Description	Quantity/ Case (pcs.)
44450	4-piece cup set - 1/4 Cup (60 mL), 1/3 Cup (80 mL), 1/2 Cup (125 mL), 1 Cup (250 mL)	1

TIMERS NEW

Item	Description	Quantity/ Case (pcs.)
47226	Stainless Steel Timer, 60 Minutes	12
47227	LCD Digital Timer, Hour/Minute	12
47228	LCD Digital Timer, Minute/Second	12



47228



47226



47227

COMMERCIAL MANUAL CAN OPENERS

FEATURES

- Designed for medium duty
- Convenient and easy way to open all sizes of cans
- Gears and knives can be removed for easy clean up and replacement
- Made of rugged cast iron construction

Item	Description	Quantity/ Case (pcs.)
10576	Can Opener (Edlund 11") # 1 with standard base. Industry Standard. For use with cans up to 11" high	1
10577	Can Opener (Edlund 7") # 2 with standard base. Industry Standard. For use with cans up to 7" high	1
14826	Edlund # 1 Knife	1
14831	Edlund # 2 Knife	1
14821	Edlund # 1 Gear	1
14822	Edlund # 2 Gear	1



ECONOMY CAN OPENERS

FEATURES

- Item 10582 For use with cans up to 11" high. The OC-CO line is fully compatible and interchangeable with the industry standard
- Item 10583 Smaller model, for cans up to 7". Parts are interchangeable with the industry standard

Item	Description	Quantity/ Case (pcs.)
10582	Omcan #1 Can Opener	1
10583	Omcan #2 Can Opener	1
14717	Omcan # 1 Knife	1
14736	Omcan # 2 Knife	1
14720	Omcan # 1 Gear	1
14726	Omcan # 2 Gear	1



HEAVY-DUTY ALUMINUM BUCKET OPENER

FEATURES

- Rugged aluminum construction
- Easily remove and reseal lids from 4, 5, 6, gallon buckets

Item	Description	Quantity/ Case (pcs.)
13946	Rugged Aluminum Bucket Opener 21"	1

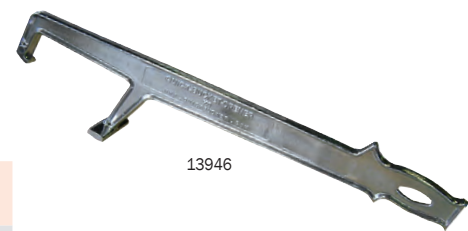

PLASTIC BUCKET OPENER

FEATURES

- Sturdy one-piece plastic safely removes lids without distorting
- Dishwasher safe
- For heavy-duty applications

Item	Description	Quantity/ Case (pcs.)
43053	Narrow Plastic Bucket Opener 8"	1

